

7210 MTS

Optoelectrical Measuring System for Separation Zone and Sludge Level Detection



In many instances in process engineering, suspensions are separated into their solid and liquid components by sedimentation.

To operate this process economically and efficiently in practice, it is indispensable to monitor the separation and transition zones of the clarification and settling phases continuously.

Applications

- Wastewater treatment:
sludge thickener, secondary clarifier
- Water purification:
settling basin after flocculant dosage,
sludge height in contact sludge
process
- Mining:
thickening during coal washing
process
- Chemical industry:
static separation process

Benefits at a glance

- Reliable concentration measurement using optical measuring process
- Direct, continuous measurement of concentration levels using zone-tracking immersion sensor
- Parallel concentration measurement and height measurement for sludge profile evaluation
- Simple configuration, calibration and adjustment via menu-assisted user interface
- Backlit display
- Sensor with 4-beam pulsed light technology
- Safe position of sensor with Hold function for measured values during scraper passage
- Measured value pre-processing in sensor reduces susceptibility to interference during signal transfer
- Sensor replaceable without recalibration in most cases

Measuring instrument

System design

- 1 Cable entries
- 2 Terminal chamber
- 3 Electronics housing
- 4 User interface
- 5 Slipping
- 6 Cable drum
- 7 Cable guide
- 8 Turbidity sensor with sensor weight and protection guard
- 9 Stepper motor controller
- 10 Stepper motor
- 11 Toothed belt ratio
- 12 Heater with thermostat

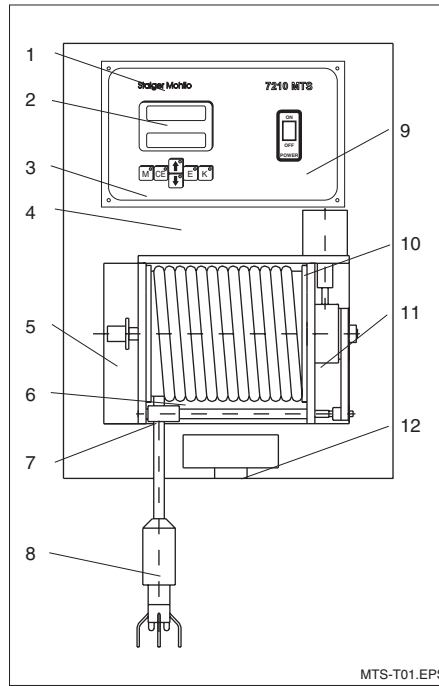

The complete measuring system is installed in a closed plastic housing.

The main system components include:

- turbidity measuring transmitter
- turbidity sensor
- stepper motor controller
- tracking unit (motor, cable drum, signal transfer)

The instrument is specially designed as a field housing for use outdoors and in industrial plants. Most of the mechanical parts are made of stainless steel or plastic.

Measuring principle

Multi-beam pulsed light process

The MTS 7210 measuring system was specially designed to detect separation zones and sludge levels in sedimentation processes. Separation zones are detected by measuring turbidity. This process is based on the conventional multi-beam pulsed light principle.

Turbidity is measured by light absorption. The monochromatic light sources are two long-life LEDs ($\geq 20,000$ operating hours).

To eliminate interference from extraneous light sources, the LEDs are pulsed at a rate of several kHz.

The signals of the two photodetectors are separately converted into logarithmic functions and set into relation. This compensates for both sensor fouling and component ageing.

Principle of measuring light emission

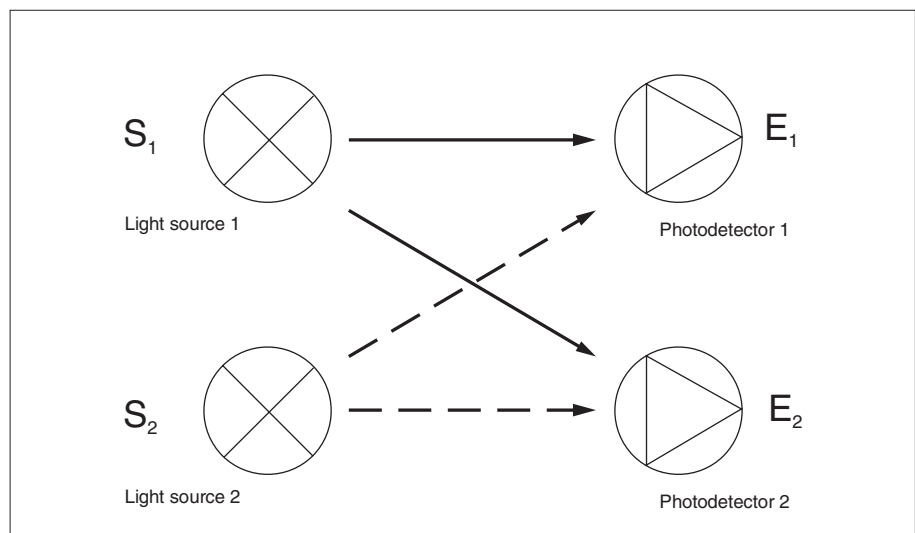

Function

The sensor generates a turbidity or solids-dependent absorption signal which is converted into a frequency signal. The frequency signal is transferred without interference via sliprings made of stainless steel.

The measured signal is compared with a preselected reference value for sludge concentration in the measuring transmitter. If there is a deviation, the sensor moves either up or down until it obtains the reference concentration (separation zone).

In order to save time, the tracking speed is controlled. This means that the greater the difference between the actual and reference concentration, the faster the sensor approaches the separation zone. The plastic cable drum used for this purpose is driven by a low-maintenance stepper motor.

An electronic device determines the sludge level height from the number of steps carried out by the stepper motor and supplies the result as an analogue signal. To avoid incorrect signals caused by stepper losses, e.g. power failure or maintenance work, an automatic zero point compensation of the height measurement takes place. For this the sensor moves to a specific reference point.

A synchronisation input allows the sensor to run up quickly.

This is required for the following situations:

- scraper passage
- sensor cleaning
- safety shut-down

The analogue signal is held during this time at the value last measured. When the synchronisation contact opens, the sensor moves to its original position and sends the current measured value again. An additional alarm contact signals when the measuring range is exceeded or when the sensor is soiled.

User interface

- 1 Large 14 mm display
4 1/2-digit for current sludge level depth
- 2 LC display for menu guidance
- 3 Membrane keypad
- 4 Mains switch

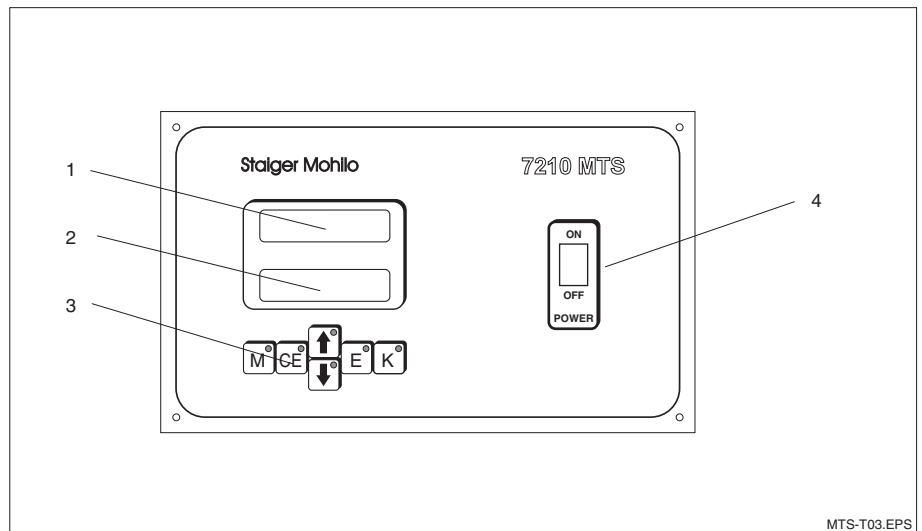

Operation

The MTS 7210 can be completely set up and calibrated via the dirt-proof membrane keypad. The operator is guided interactively through the operating menu. The interface is a two-line plaintext display.

A language selection menu permits the device to be operated in various languages.

Programming levels which go beyond everyday operation processes are only accessible by entering a password.

All the calibration data and parameters are retained if there is a power failure or when the device is shut down (non-volatile RAM).

Dimensions

Dimensions of measuring transmitter

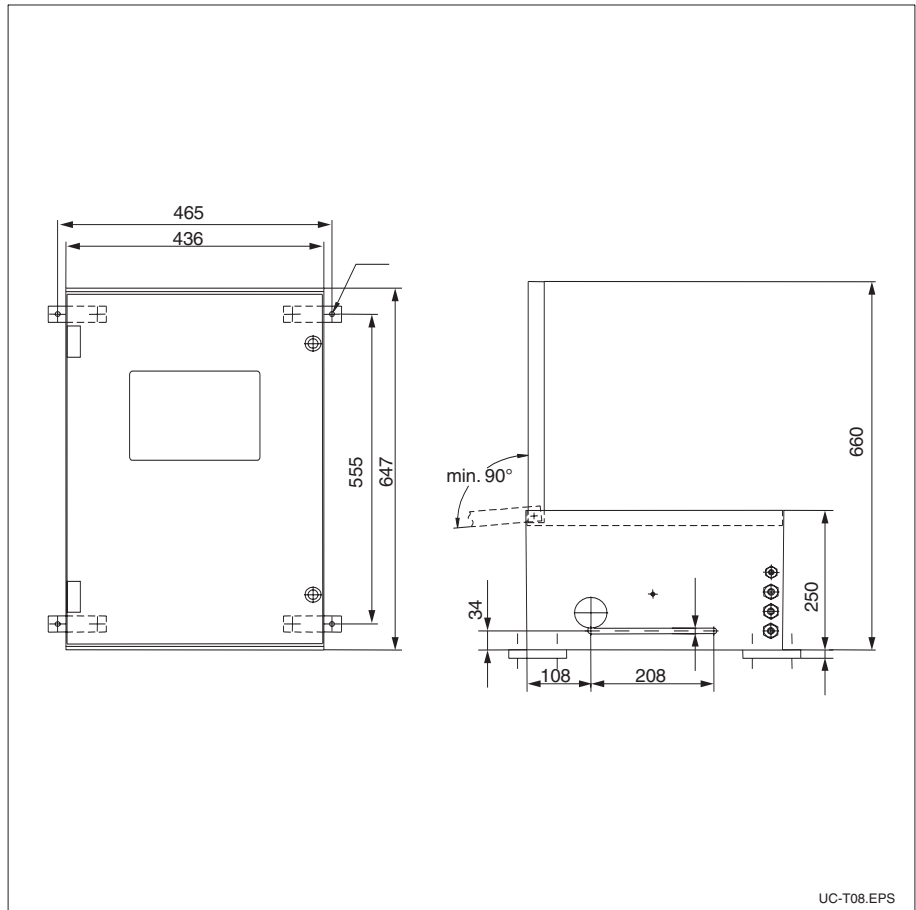

Dimensions of sensor

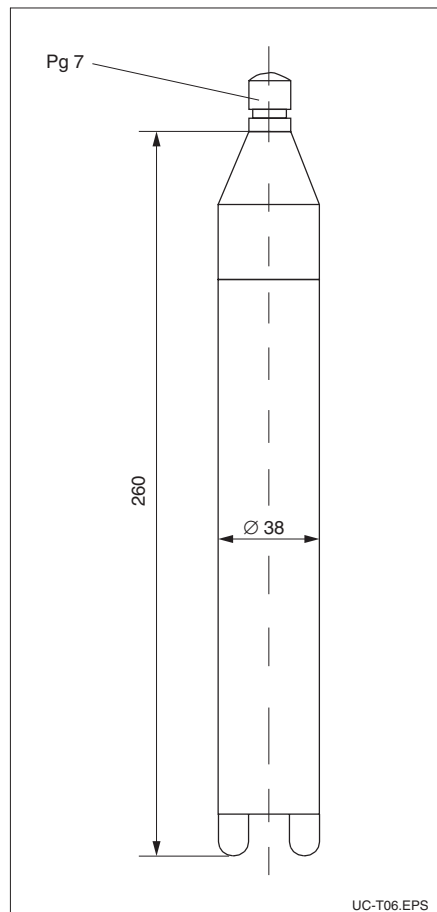

Installation

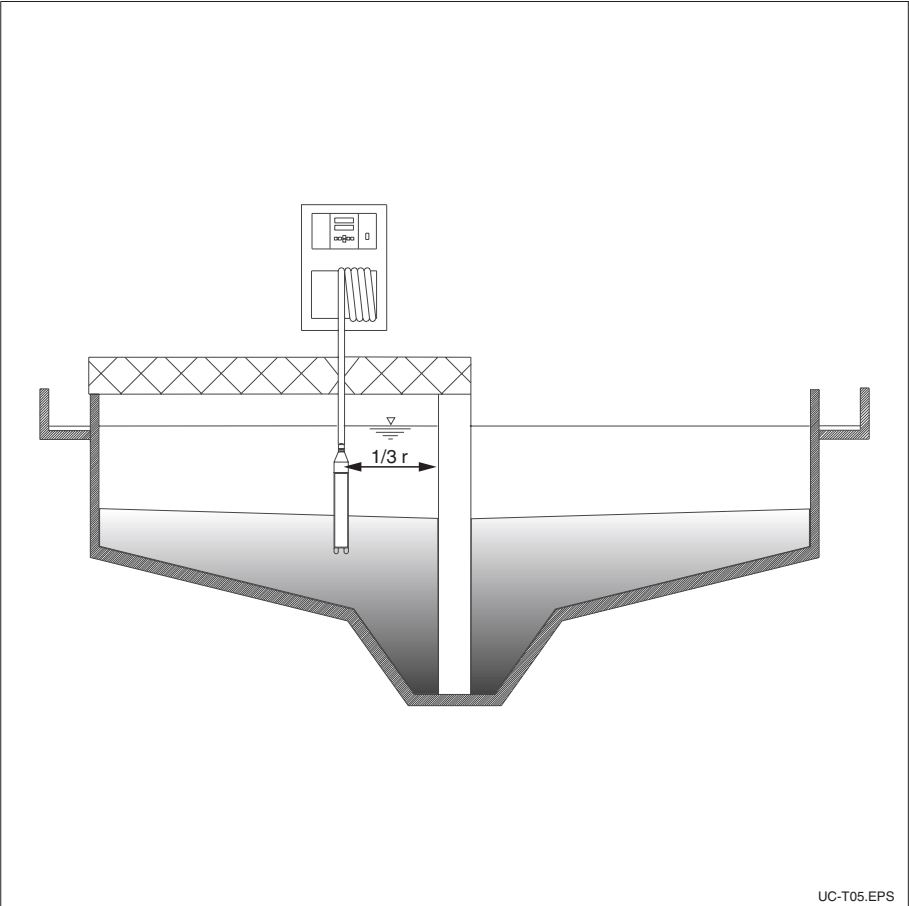

Continuous sludge level measurement in secondary clarifier. Installation on scraper bridge

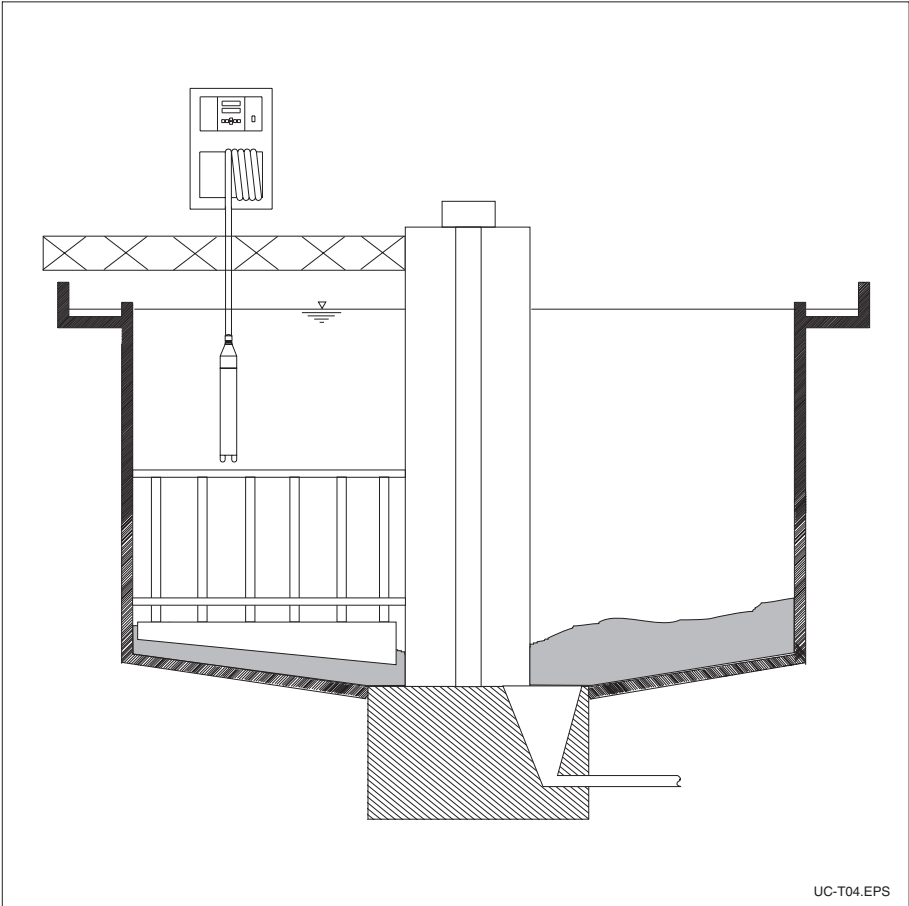

Continuous separation zone measurement in sludge thickener

Technical data

General data	Manufacturer	ISI Europa
	Product designation	Sludge level measuring system 7210 MTS
Measuring transmitter		
Mechanical data	Dimensions (L x W x D)	647 x 436 x 250 mm
	Total weight including sensor and tracking unit	approx. 30 kg
	Display	LED display (14 mm) for current measured value, 2-line LC display (5 mm) for programming
Materials	Housing	Polyester Connector between electronics and tracking unit
	Sight glass	Polycarbonate
	Protection class	IP 30
Input	Signal input 1	Measuring input
	Measured variable	Turbidity measurement, height measurement
	Principle of turbidity measurement	Multi-beam pulsed light process
	Measuring light	Infrared light at 880 nm
	Measuring range	0 ... 12 g/l
	Accuracy	±1 % of measured value
	Reproducibility	0.5 %
	Height measurement	Stepper motor control
	Measuring range	0 ... 11 m, free parameter entry
	Signal input 2 (24 V DC)	Synchronisation, e.g. to run up sensor during scraper passage
	Signal input 2 (24 V DC)	Profile run
Output	Signal output 1	0/4 ... 20 mA for sludge level measurement (height)
	Signal output 2	0/4 ... 20 mA for solids measurement (concentration)
	Load	Max. 500 Ω
	Switching outputs	2 limit contacts, freely configurable 1 relay contact for sensor cleaning, 1 relay contact for alarm signal 1 relay contact each for messages 1 and 2
	Switching power	2 A at 115/230 V AC, 1 A at 30 V DC
	Electrical connection	Power supply
Power consumption		Max. 105 VA (electronics + heater)
Heater	Heating capacity	Thermostatically controlled, 55 VA
Ambient conditions	Ambient temperature	-20 ... +60 °C
Reeling unit		
Components	Cable drum (w x Ø)	210 x Ø 160 mm
	Cable length	13 m
	Drive	Stepper motor with worm gear and toothed belt
	Stepping rate	200 steps per revolution
	Signal transfer	Noble metal sliprings
	Zone-tracking speed	Max. 10 cm /s
Sensor		
Physical data	Dimensions	260 x Ø 38 mm
	Material	
	Sensor	Stainless steel SS 316 Ti and polyoxymethylene (POM)
	Sensor cable	Polyurethane jacket
	Sensor weight	Stainless steel SS 316 Ti and polyamide 6.6 GFRP
	Protection guard	Stainless steel SS 316 Ti
Height measurement	Max. sensor stroke	11.4 m
Operating conditions	Max. temperature	50°C
	Pressure	max. 6 bar

Subject to modifications.

Accessories

- ❑ Railing-mounting bracket with weather protection cover
Order No.: 51503584
- ❑ Cleaning brush for cable
Order No.: 51503585
- ❑ Sensor rinsing device stainless steel VA, DN 200
incl. solenoid valve
Order No.: 51503586
- ❑ Sensor rinsing device plastic PP, DN 300
incl. solenoid valve
Order No.: 51503587
- ❑ Sensor protection guard with 90° angle bracket
Order No.: 51503783

ISI Europa
P. O. Box 10 01 54
D-70826 Gerlingen
Tel. +49-71 56-2 09-2 18
Fax +49-71 56-2 65 71

